

Ratchets supplied with plastic handle grip sleeve

Socket Size	Part Number	Rating
7/32	BR100-218	150 lb/in
1/4	BR100-250	150 lb/in
9/32	BR100-281	150 lb/in
5/16	BR100-312	150 lb/in
11/32	BR100-343	150 lb/in
3/8	BR100-375	150 lb/in
7/16	BR100-437	150 lb/in

Metric socket sizes on request.

Key Features:

- Reversing Action
- Solid Construction
- 7 Sizes: 7/32 to 7/16
- 10° Ratchet Index
- Shallow Socket

Standard Finish: Black Oxide

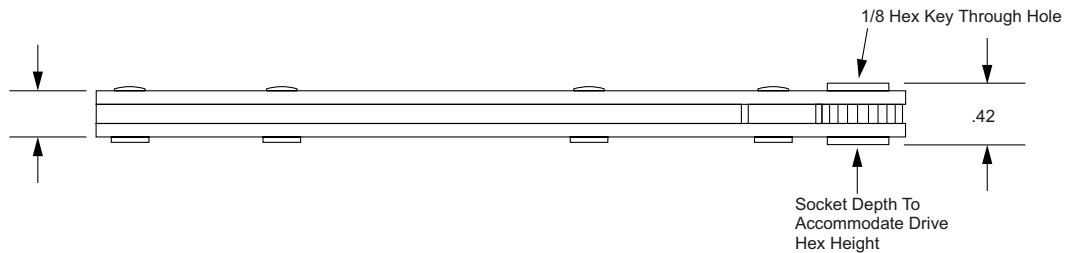
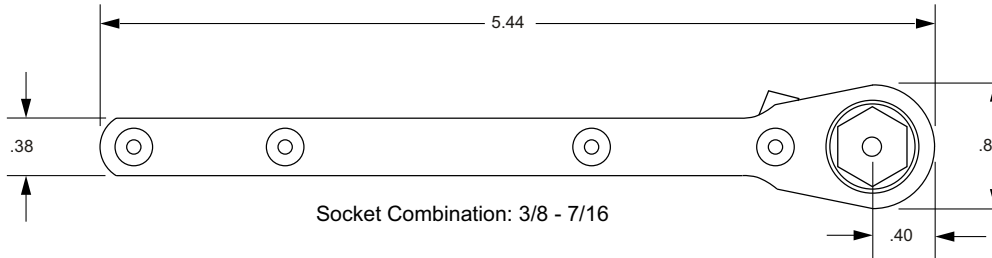
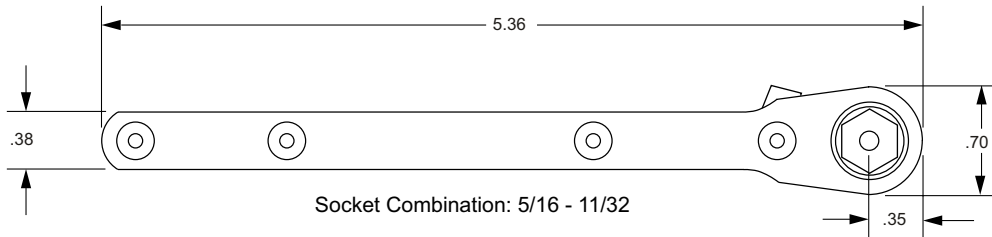
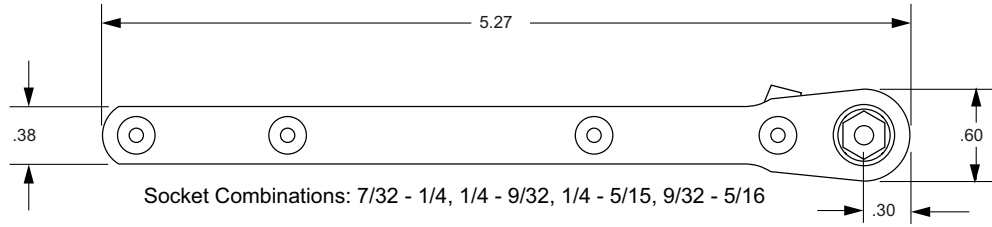

Ratchets supplied with plastic handle grip sleeve

Socket Combinations	Part Number	Rating
7/32 - 1/4	BR100-218-250	150 lb/in
1/4 - 9/32	BR100-250-281	150 lb/in
1/4 - 5/16	BR100-250-312	100 lb/in*
9/32 - 5/16	BR100-281-312	100 lb/in*
5/16 - 11/32	BR100-312-343	150 lb/in
5/16 - 3/8	BR100-312-375	150 lb/in

* Lower rating due to thinner 5/16 socket wall

Key Features:

- Reversing Action
- Dual Socketed Ratchet Wheels
- Solid Construction
- 6 Combinations
- 10° Ratchet Index
- Shallow Sockets

Standard Finish: Black Oxide

Metric socket sizes on request.

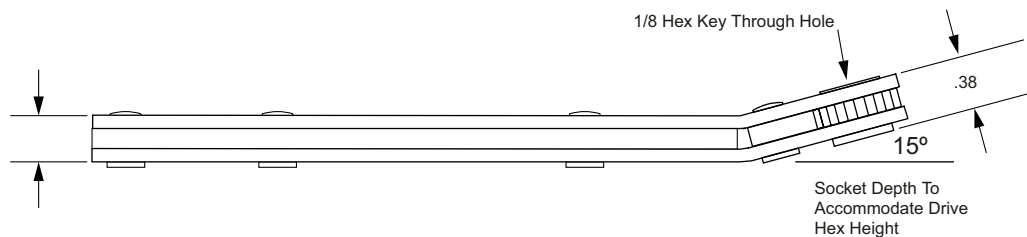
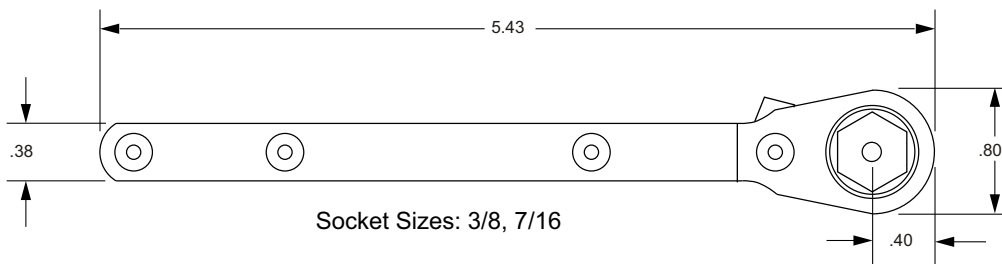
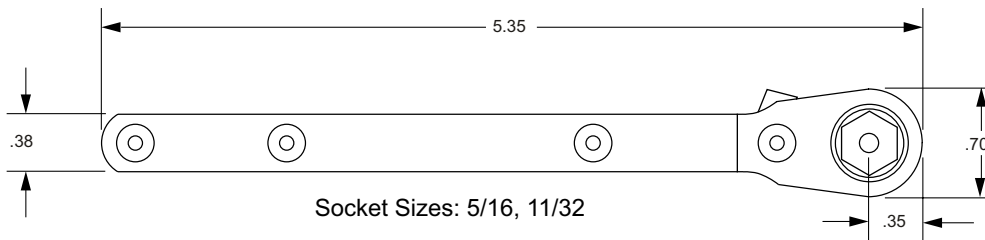
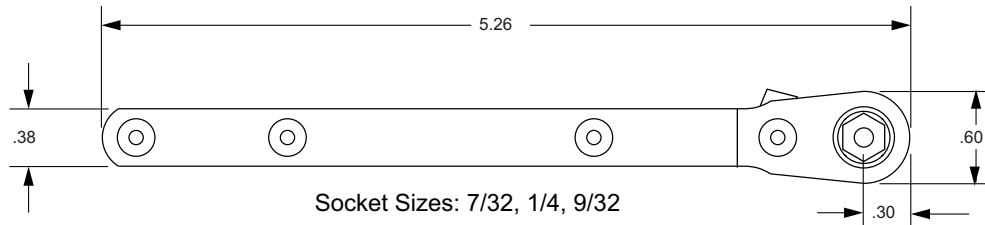

Ratchets supplied with plastic handle grip sleeve

Socket Size	Part Number	Rating
7/32	BRO100-218	150 lb/in
1/4	BRO100-250	150 lb/in
9/32	BRO100-281	150 lb/in
5/16	BRO100-312	150 lb/in
11/32	BRO100-343	150 lb/in
3/8	BRO100-375	150 lb/in
7/16	BRO100-437	150 lb/in

Metric socket sizes on request.

Key Features:

- Reversing Action
- Solid Construction
- 7 Sizes: 7/32 to 7/16
- 10° Ratchet Index
- Shallow Socket

Standard Finish: Black Oxide

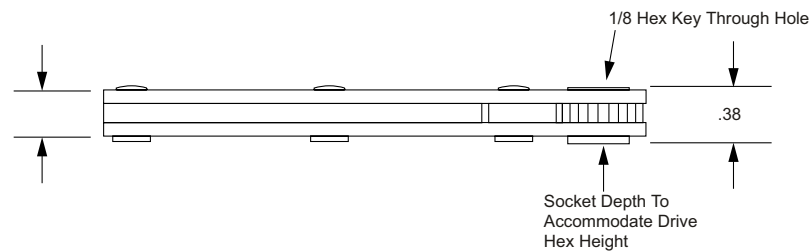
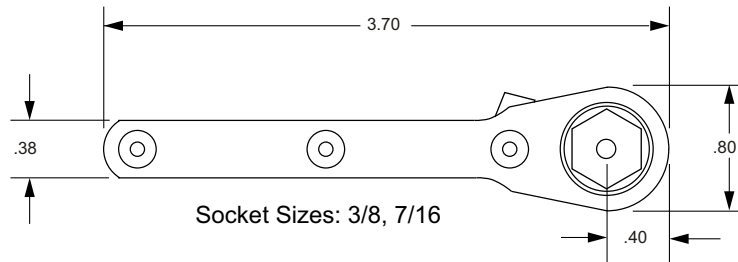
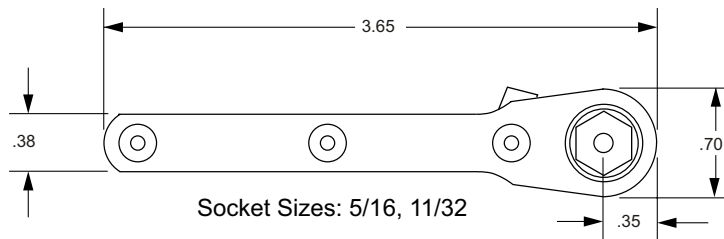
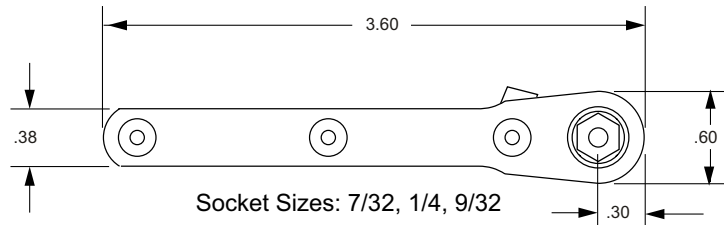

Ratchets supplied with plastic handle grip sleeve

Socket Size	Part Number	Rating
7/32	BRS100-218	120 lb/in
1/4	BRS100-250	120 lb/in
9/32	BRS100-281	120 lb/in
5/16	BRS100-312	120 lb/in
11/32	BRS100-343	120 lb/in
3/8	BRS100-375	120 lb/in
7/16	BRS100-437	120 lb/in

Metric socket sizes on request.

Key Features:

- Reversing Action
- Solid Construction
- 7 Sizes: 7/32 to 7/16
- 10° Ratchet Index
- Shallow Socket

Standard Finish: Black Oxide

Fast-Tool

BR200-() Straight Handle Series Box Ratchet Wrench

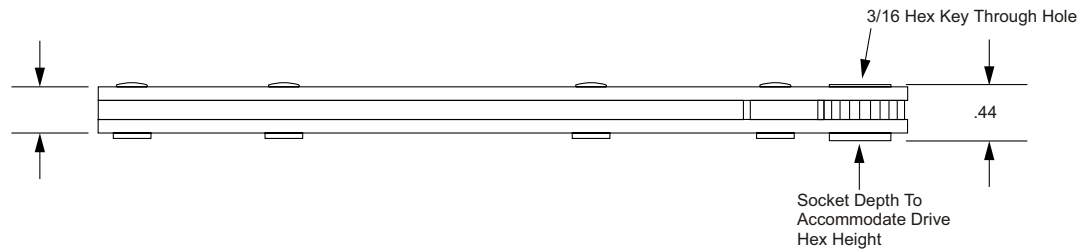
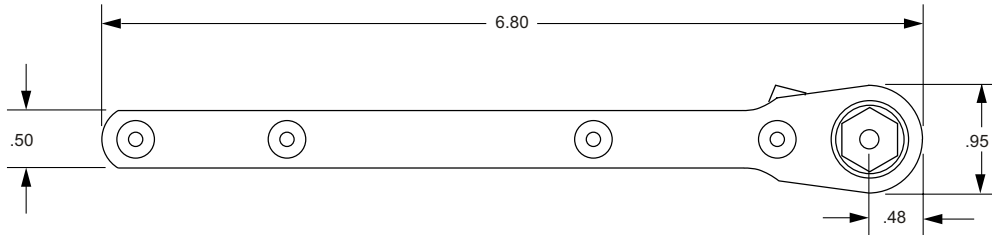

Ratchets supplied with plastic handle grip sleeve

Socket Size	Part Number	Rating
3/8	BR200-375	300 lb/in
7/16	BR200-437	300 lb/in
1/2	BR200-500	300 lb/in
9/16	BR200-562	300 lb/in

Metric socket sizes on request.

Key Features:

- Reversing Action
- Solid Construction
- 10° Ratchet Index
- Shallow Socket

Standard Finish: Black Oxide

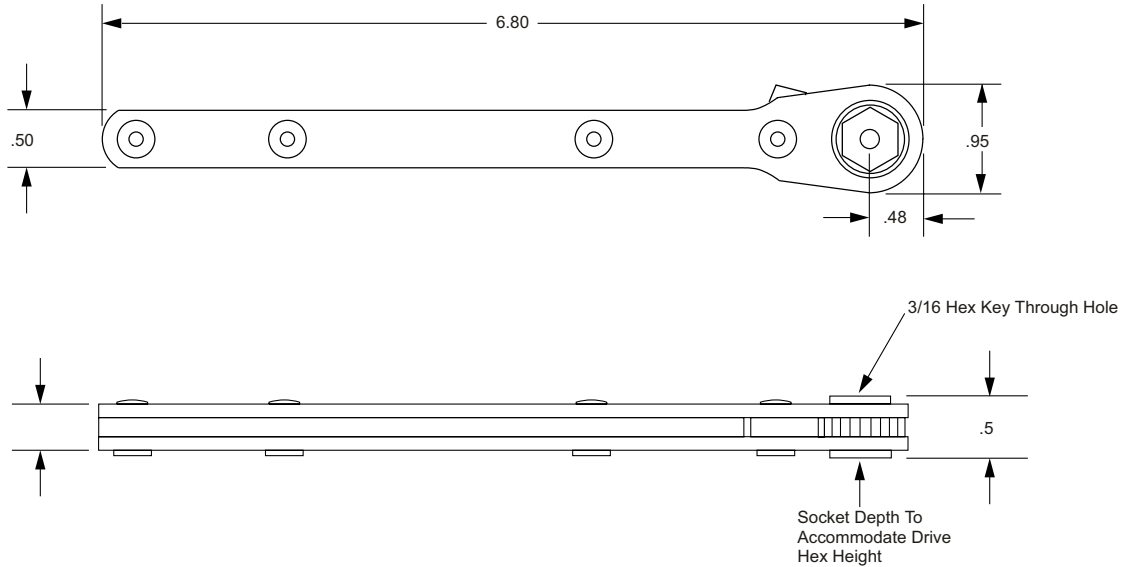

Ratchets supplied with plastic handle grip sleeve

Socket Combinations	Part Number	Rating
3/8 - 7/16	BR200-375-437	300 lb/in
7/16 - 1/2	BR200-437-500	300 lb/in
1/2 - 9/16	BR200-500-562	300 lb/in

Metric socket sizes on request.

Key Features:

- Reversing Action
- Solid Construction
- Dual Socket Ratchet Wheels
- 10° Ratchet Index
- Shallow Socket

Standard Finish: Black Oxide

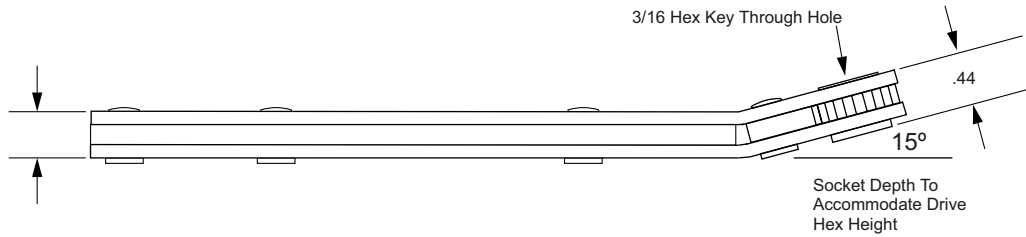
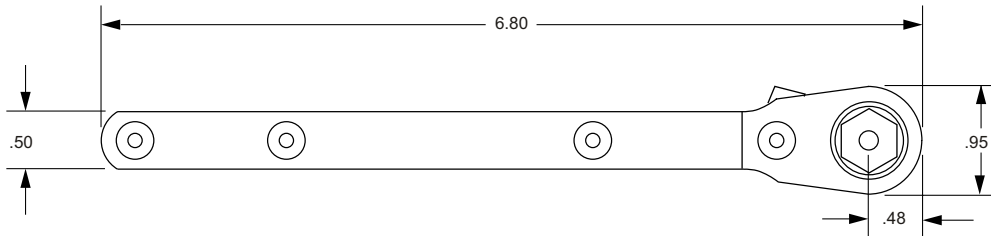

Ratchets supplied with plastic handle grip sleeve

Socket Size	Part Number	Rating
3/8	BRO200-375	300 lb/in
7/16	BRO200-437	300 lb/in
1/2	BRO200-500	300 lb/in
9/16	BRO200-562	300 lb/in

Metric socket sizes on request.

Key Features:

- Reversing Action
- Solid Construction
- 10° Ratchet Index
- Shallow Socket

Standard Finish: Black Oxide

Fast-Tool

BR300-() Straight Handle Series Box Ratchet Wrench

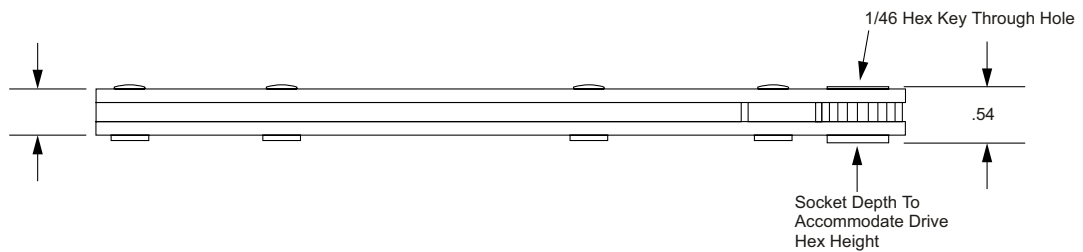
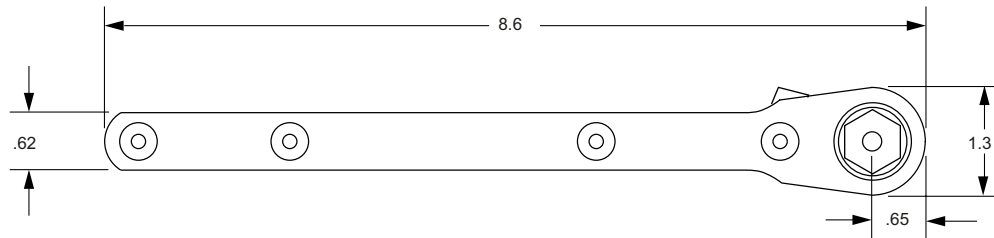

Ratchets supplied with plastic handle grip sleeve

Socket Size	Part Number	Rating
5/8	BR300-562	600 lb/in
11/16	BR300-687	600 lb/in
3/4	BR300-750	600 lb/in

Metric socket sizes on request.

Key Features:

- Reversing Action
- Solid Construction
- 10° Ratchet Index
- Shallow Socket

Standard Finish: Black Oxide

Fast-Tool

BRO300-() Straight Handle Series Box Ratchet Wrench

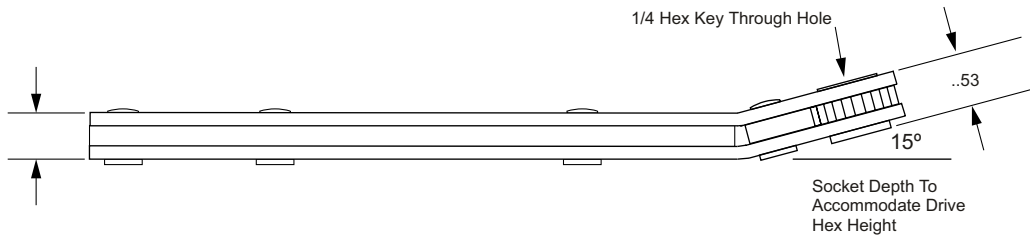
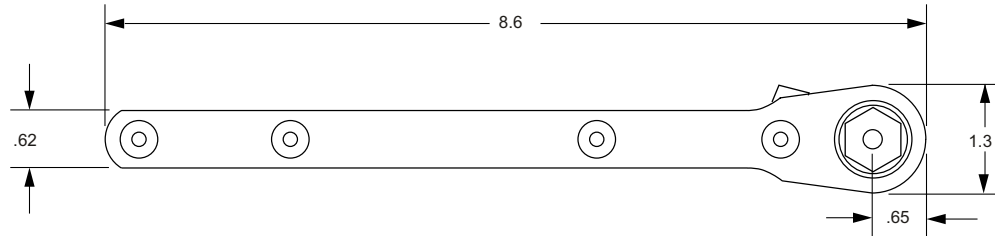

Ratchets supplied with plastic handle grip sleeve

Socket Size	Part Number	Rating
5/8	BRO300-562	600 lb/in
11/16	BRO300-687	600 lb/in
3/4	BRO300-750	600 lb/in

Metric socket sizes on request.

Key Features:

- Reversing Action
- Solid Construction
- 10° Ratchet Index
- Shallow Socket

Standard Finish: Black Oxide

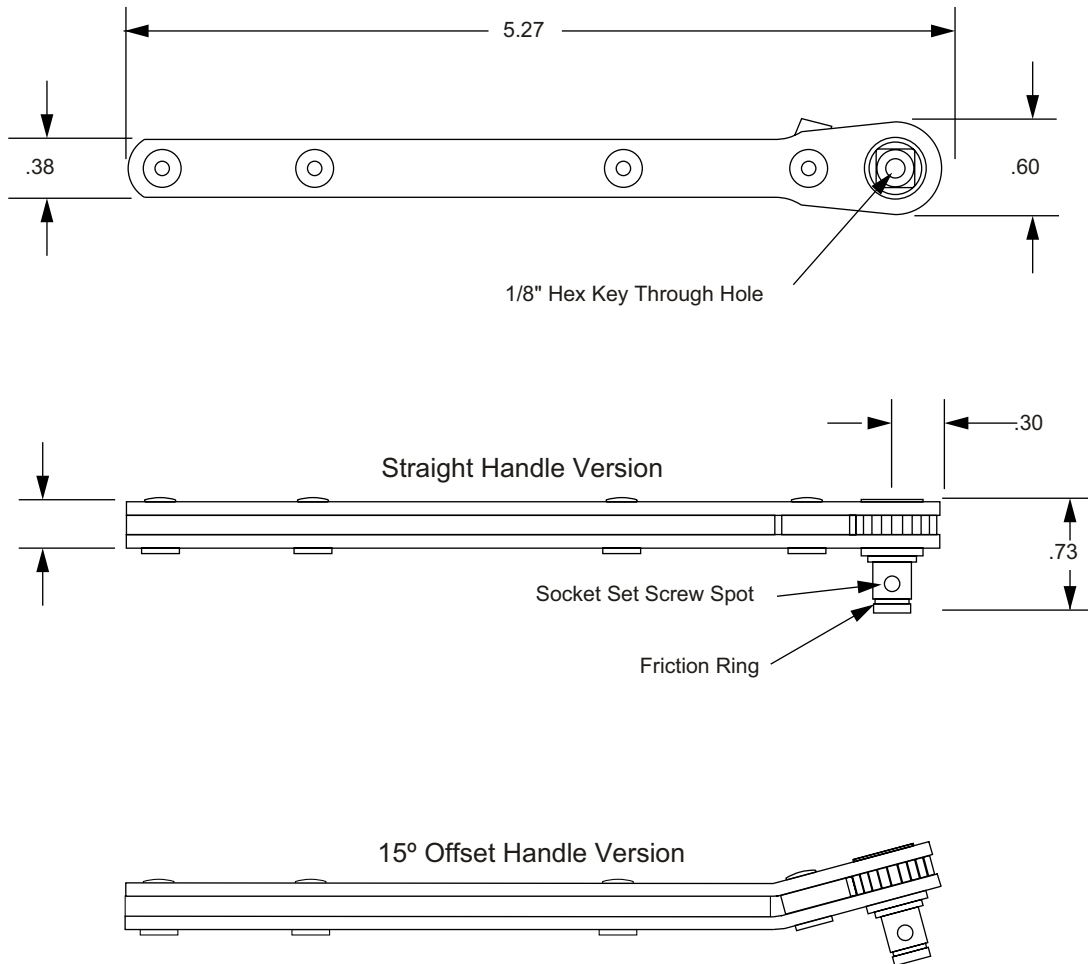

- Key Features:
- Compact Design
 - 150 lb/in Rating
 - 10° Ratchet Index
 - Reversing Action

Standard Finish: Black Oxide

Ratchet supplied with plastic handle grip sleeve

Use With Fast-Tool S100 Series Low Profile Frangible Collar Sockets

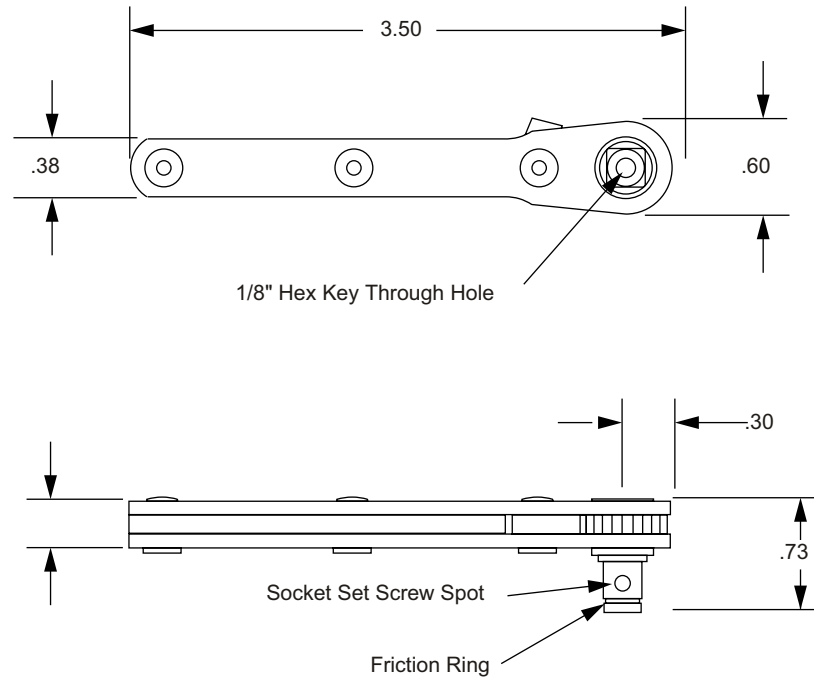

Key Features:

- Compact Design
- 120 lb/in Rating
- 10° Ratchet Index
- Reversing Action

Standard Finish: Black Oxide

Use With Fast-Tool S100 Series Low Profile Frangible Collar Sockets

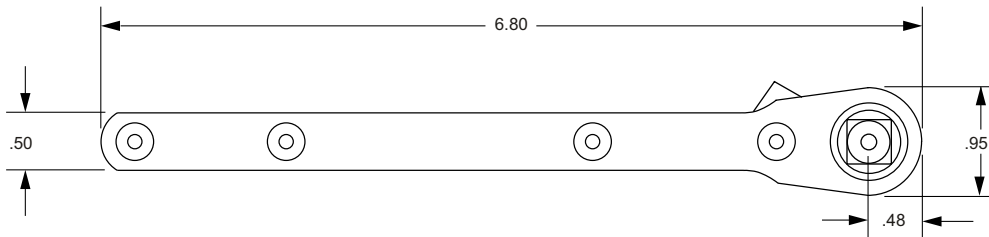

Straight Handle Version

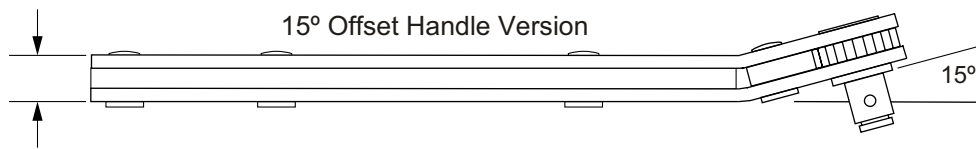
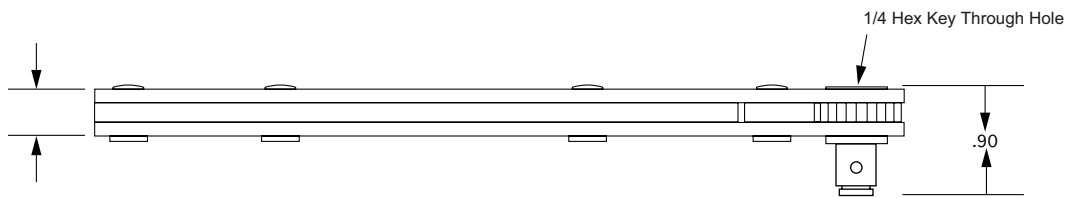

Key Features:

- Compact Design
- 300 lb/in Rating
- 10° Ratchet Index
- Reversing Action

Standard Finish: Black Oxide

Ratchet supplied with plastic handle grip sleeve

Fast-Tool

FR250-38 Straight Handle FRO250-38 Offset Handle 3/8" Drive Ratchet, Minimum Edge Distance

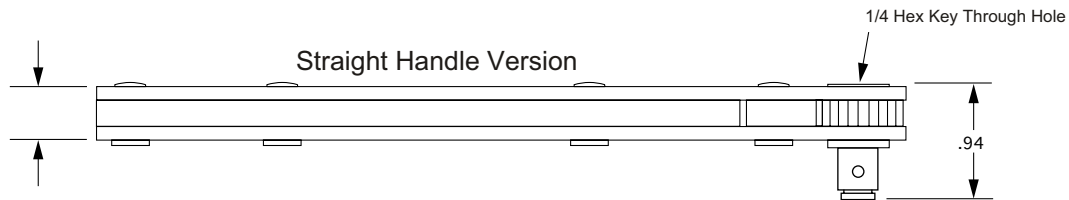
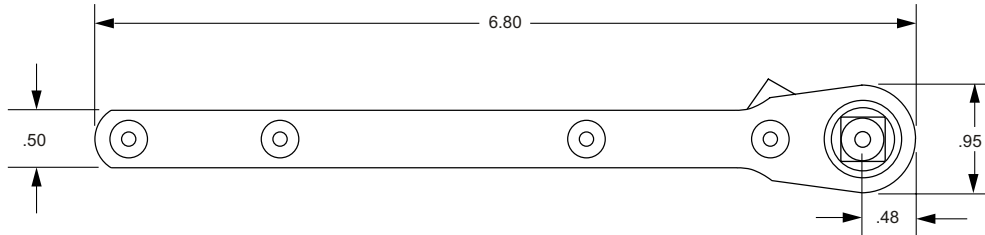

15° Offset Handle Version

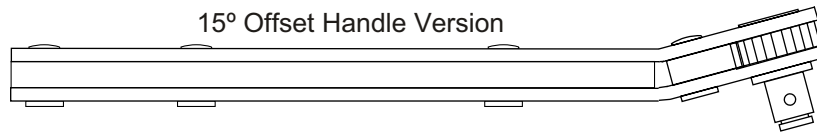

Key Features:

- Compact Design
- 450 lb/in Rating
- 10° Ratchet Index
- Reversing Action

Standard Finish: Black Oxide

Ratchet supplied with plastic handle grip sleeve

Fast-Tool

FR300-50 Straight Handle FRO300-50 Offset Handle 1/2" Drive Ratchet, Minimum Edge Distance

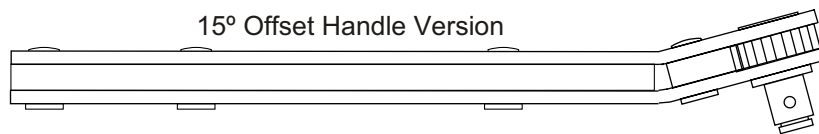
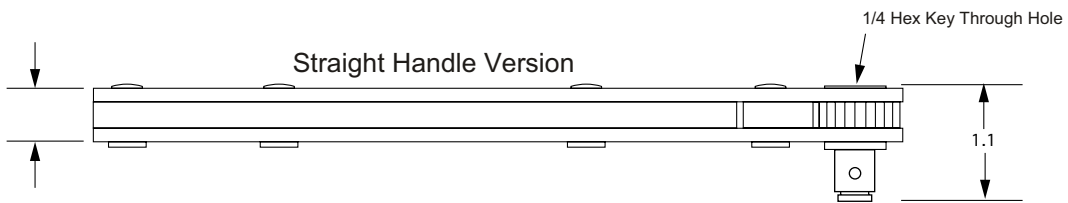
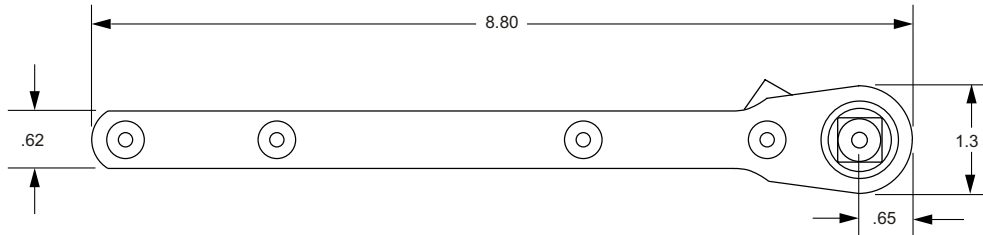

Key Features:

- Compact Design
- 600 lb/in Rating
- 10° Ratchet Index
- Reversing Action

Standard Finish: Black Oxide

Ratchet supplied with plastic handle grip sleeve